

RapidFit™

BY REARO

technical specifications & product guide



REARO
we make it simple

RapidFit™
by REARO™
the advantages

RapidFit™ is the revolutionary new system from **Rearo** in integrated washroom suites.

Designed to be ideal for the majority of room environments, **RapidFit™** is a simple, modern system that does not compromise on quality.

The range has been tailored to suit the needs of the customer, available in convenient packs and a variety of colours, the system incorporates most standard sanitaryware sizes.

Concealed cistern wall panels in Nova Lilas



Available Colours:

Nova Lilas

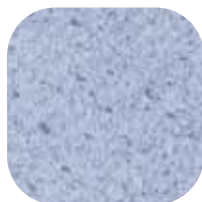

Maryland Clair









Cosmic Beige



Blanc Menuires



-  available 'off the shelf' from your local distributor.
-  available in four popular washroom colours - Nova Lilas, Maryland Clair, Cosmic Beige and Blanc Menuires by Polyrey.
-  system is designed to incorporate most standard sanitaryware sizes and covers entire washroom area. Including cubicles, vanity units, wall panels and access panels.
-  all components are well manufactured in 19mm moisture resistant MFC (melamine faced chipboard) with robust 2mm colour matched pvc edging.
-  all wall panels are fully de-mountable to allow maintenance access (with no face fixings showing).
-  all cubicles are supplied with the necessary corrosion resistant satin anodised aluminium ironmongery with anti-vandal screw fixings.
-  all components are supplied flat packed and well packaged.
-  all cubicle door panels come pre-routed for indicator bolt fitment.
-  loose edging available for on-site alterations, colour matched sealant available.
-  special sizes available on request.
-  system available for disabled outward opening cubicles and transverse / in-line arrangements.
-  nursery cubicles available by special request.
-  all cubicles include toilet roll holder and hat & coat hook as standard.

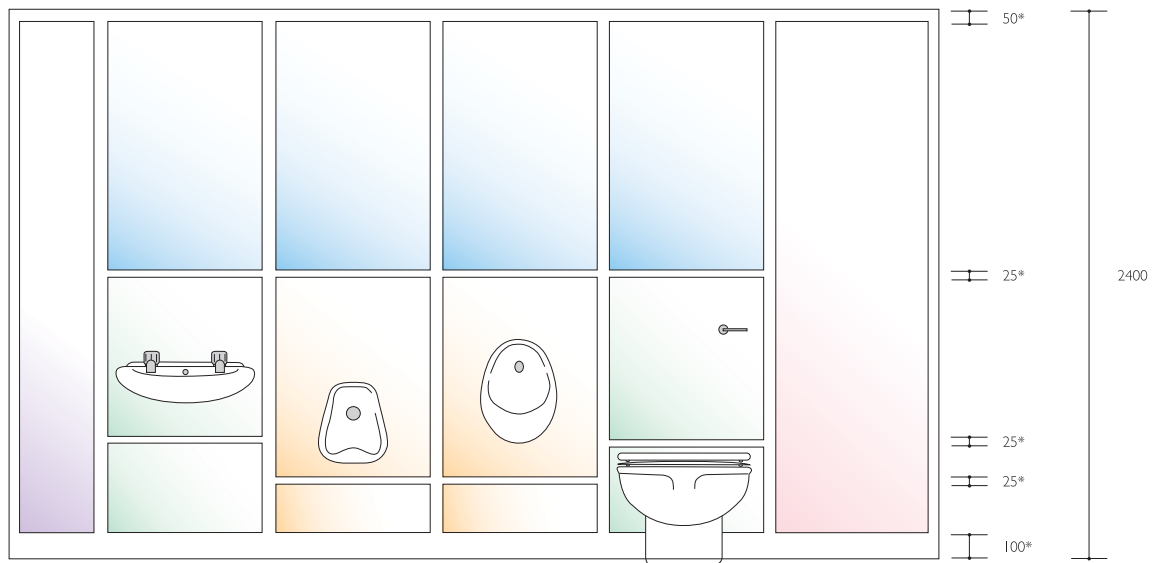
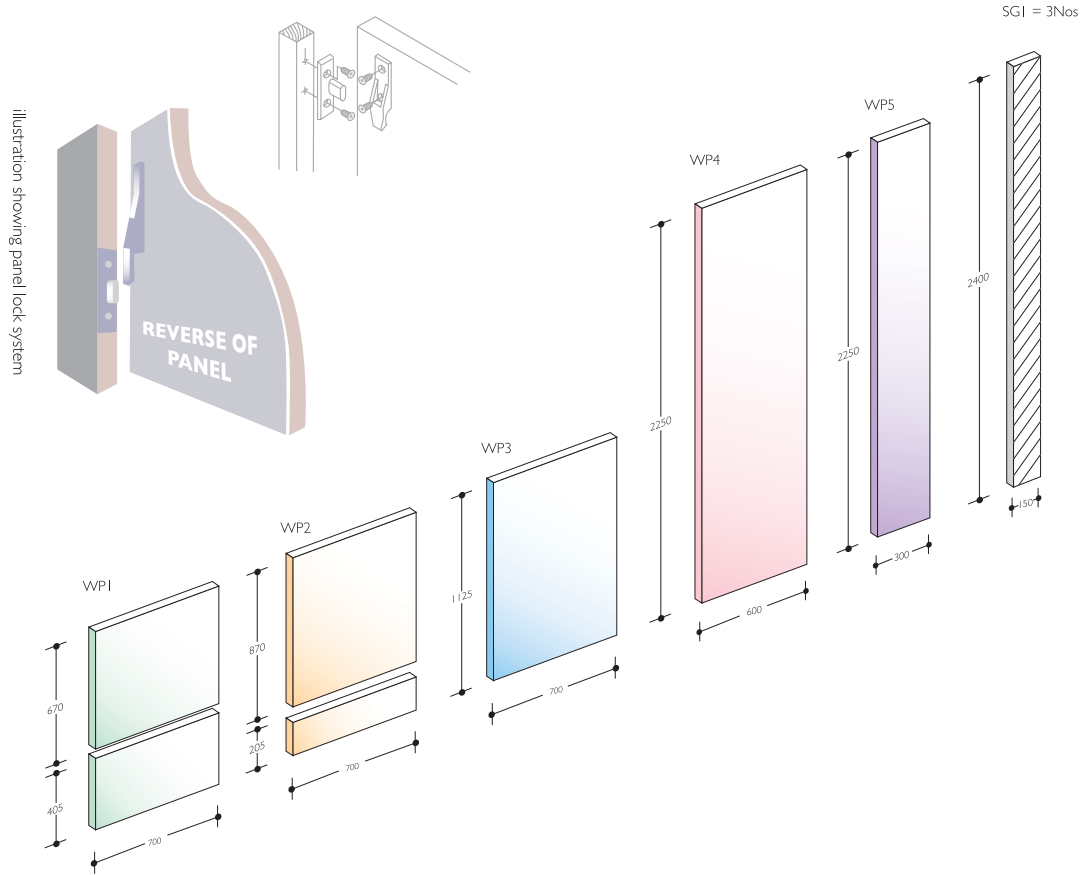

*Suggested Shadow Gap sizes.

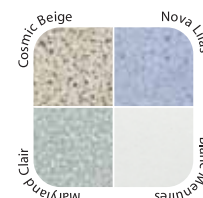

RapidFit™ panels are specially designed to accommodate wc's, washbasins and urinals.

Maintenance is simple with all panels fully de-mountable, allowing easy access without compromising aesthetics.

WP1	12 kg*
1 x (670 x 700 x 19mm) MFC wall panel	
1 x (405 x 700 x 19mm) MFC wall panel	
8 x Rearo gravity fixing clips + screws	

WP2	10 kg*
1 x (870 x 700 x 19mm) MFC wall panel	
1 x (205 x 700 x 19mm) MFC wall panel	
8 x Rearo gravity fixing clips + screws	

WP3	15 kg*
1 x (1125 x 700 x 19mm) MFC wall panel	
8 x Rearo gravity fixing clips + screws	

WP4	20 kg*
1 x (2250 x 600 x 19mm) MFC wall panel	
8 x Rearo gravity fixing clips + screws	

WP5	10 kg*
1 x (2250 x 300 x 19mm) MFC wall panel	
8 x Rearo gravity fixing clips + screws	

SG1	15 kg*
3 x (2400 x 150 x 19mm) shadow gap panels [#]	

[#] please specify preferred shadow gap colour: Black, Nova Lilas, Maryland Clair, Cosmic Beige and Blanc Menuires
*all weights are approximate

wall panelling height

wc, full height	WP1 + WP3 + SG1
wash basin full height	WP1 + WP3 + SG1
urinal, full height	WP2 + WP3 + SG1
wash basin, vanity height	WP1 + SG1
wc shelf height	WP1 + SG1**

** shelf not included



Transverse Cubicle in Cosmic Beige



Standard Cubicle (corner sited arrangement) in Maryland Clair

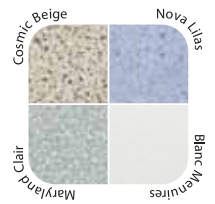

Nursery Cubicles are also available (special order)

Headrail Detail (top), Vanity Unit detail (above left), Adjustable support (above right).

corner sited between walls transverse between walls transverse corner sited transverse corner sited with outward opening disabled door

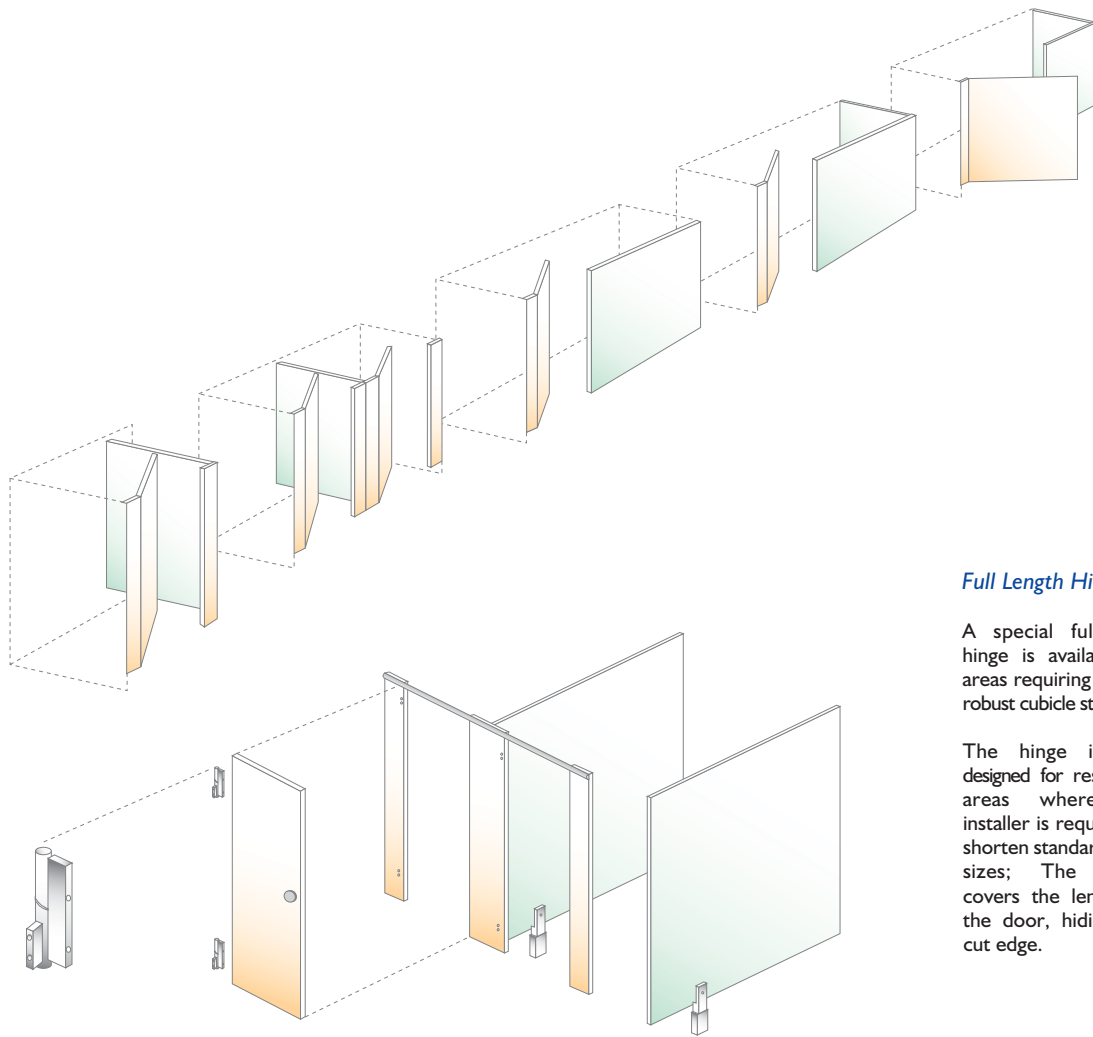
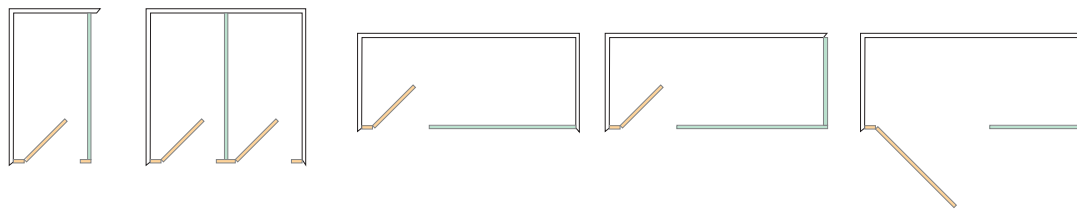

Full Length Hinge

A special full-length hinge is available for areas requiring a more robust cubicle structure.

The hinge is also designed for restricted areas where the installer is required to shorten standard door sizes; The hinge covers the length of the door, hiding the cut edge.

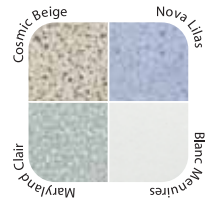

RapidFit™ cubicles are manufactured in durable 19mm moisture resistant MFC with 2mm colourmatched PVC edging.

The system easily adapts to the required layout and is supplied in tailored packs.

RapidFit™ partitions and doors are available in four packs :

cubicle partition pack **CP**

cubicle door pack **CD**

headrail **CH**

disabled door **CDD**
(1750 x 940)

CP	38 kg*
2 x (899 x 1500 x 19mm) MFC partition sections	
1 x 1500mm aluminium partition jointing section	
1 x partition ironmongery pack	

CD	30 kg*
1 x (1800 x 690 x 19mm) MFC door	
2 x (1800 x 125 x 19mm) MFC end pilasters	
1 x (1800 x 250 x 19mm) MFC mid pilaster	
1 x door ironmongery pack	

CDD	33 kg*
1 x (1750 x 940 x 19mm) MFC door	
2 x (1800 x 125 x 19mm) MFC end pilasters	
1 x (1800 x 250 x 19mm) MFC mid pilaster	
1 x door ironmongery pack	
1 x outward opening keeper	

corner sited	
No.	kit contents
1	1 cp + 1 cd + headrail
2	2 cp + 2 cd + headrail
3	3 cp + 3 cd + headrail
4	4 cp + 4 cd + 2 headrail [#]
5	5 cp + 5 cd + 2 headrail [#]

between walls	
No.	kit contents
1	1 cd + headrail
2	1 cp + 2 cd + headrail
3	2 cp + 3 cd + headrail
4	3 cp + 4 cd + 2 headrail [#]
5	4 cp + 5 cd + 2 headrail [#]

Transverse between walls
kit contents
1 cp + 1 cd + headrail [#]

transverse corner sited
kit contents
2 cp + 1 cd + headrail [#]

[#]Please note that aluminium headrail is 3000 mm long.
*all weights are approximate

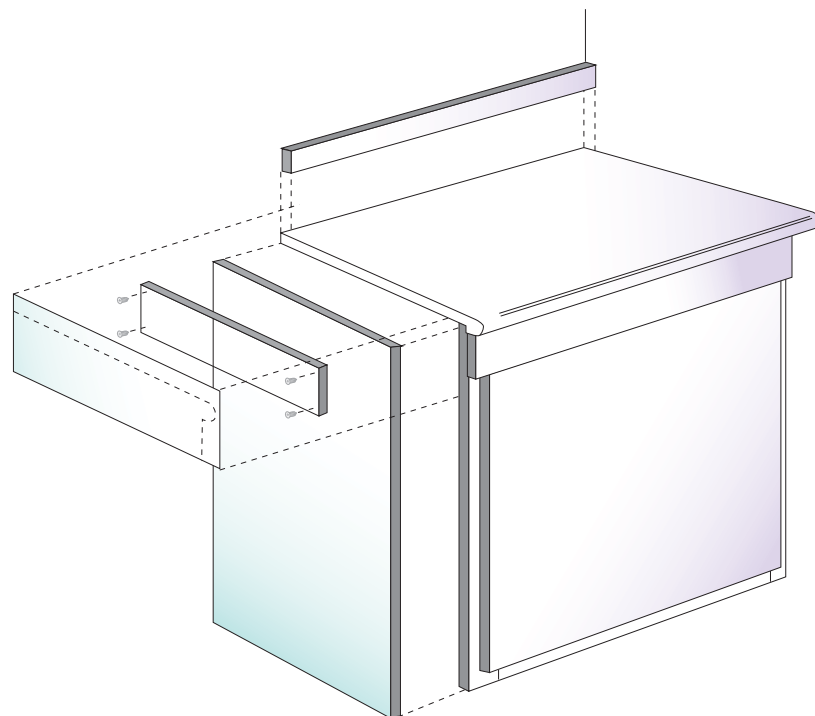
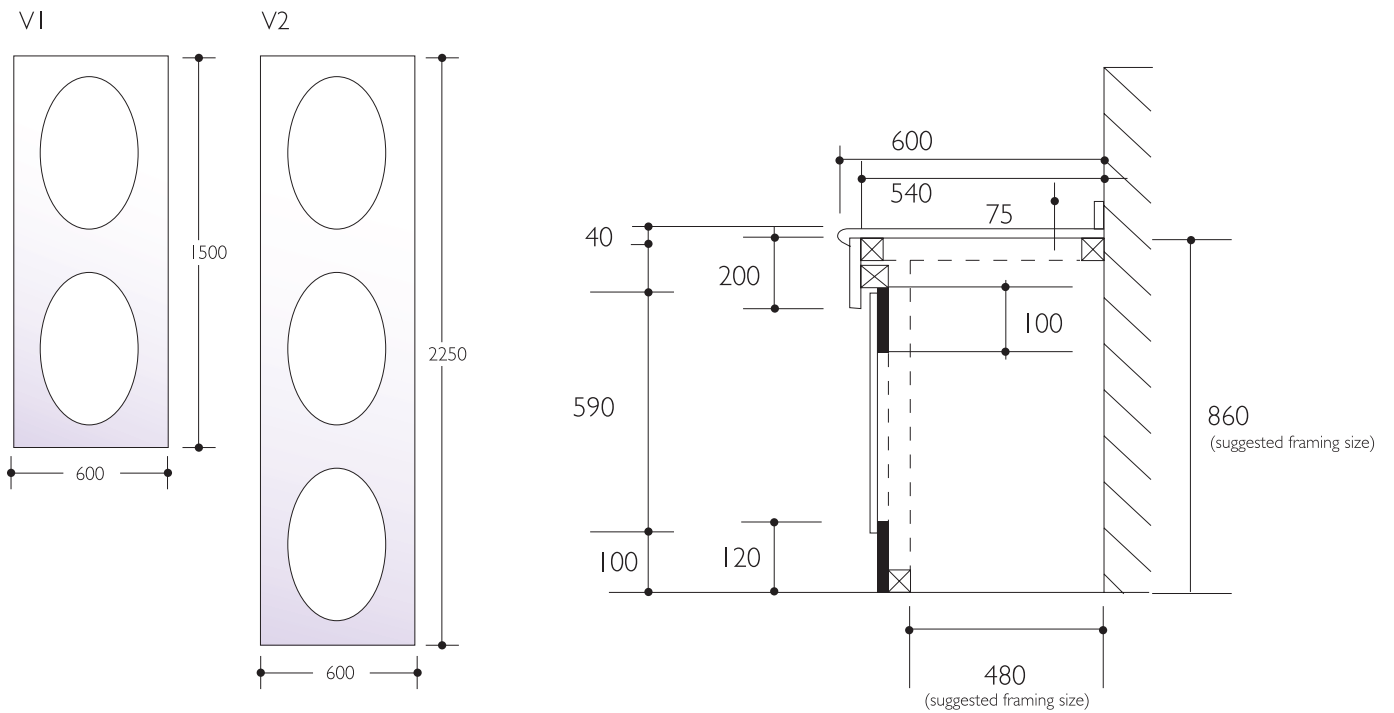

Framing and cut-outs arranged by others. Framing Not supplied.
Drawings not to scale.

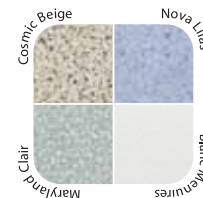

RapidFit™ Vanity Units are designed to provide an excellent alternative to panel mounted basins.

These versatile units can be tailored to suit up to three basins.

All exposed edges are rounded to avoid sharp corners.

Vanity Units come in two size specifications along with a corner sited kit.

V1	40 kg*
kit contents	
1 x (1500 x 600mm) postformed top	
1 x (1500 x 75mm) upstand	
1 x (1500 x 200mm) downstand	
1 x (1450 x 590 x 19mm) underpanel	
1 x (1500 x 120mm) shadow gap	
2 x (1500 x 100mm) shadow gap	
8 x rearo gravity fixing clips	

V2	60 kg*
kit contents	
1 x (2250 x 600mm) postformed top	
1 x (2250 x 75mm) upstand	
1 x (2250 x 200mm) downstand	
1 x (2200 x 590 x 19mm) underpanel	
1 x (2250 x 120mm) shadow gap	
2 x (2250 x 100mm) shadow gap	
8 x rearo gravity fixing clips	

corner sited	9 kg*
kit contents	
1 x (540 x 200mm) apron / downstand return <small>(18mm chipboard only)</small>	
1 x (830 x 500mm) shadow gap end panel [#]	
1 x (230 x 610mm) end capping piece <small>(laminite only)</small>	
4 x rearo push on clips	

[#] please specify preferred shadow gap colour: Black, Nova Lilas, Maryland Clair, Cosmic Beige and Blanc Menuires

*all weights are approximate

Nursery Cubicles

Rearo can, as an extension to the **RapidFit™** range, provide specialist nursery cubicles on request.

Please contact Rearo for further information.

Tel: 0141 440 0800 Fax: 0141 445 3342 www.rearo.co.uk
sales@rearo.co.uk





REARO
we make it simple

Loanbank House, Loanbank Quadrant, Govan, Glasgow, G51 3HZ
Tel: 0141 440 0800 Fax: 0141 445 3342
www.rearo.co.uk sales@rearo.co.uk



Rearo Supplies Limited
Unit 15 & 16
Dunfermline Business Park
Rosyth
Fife
KY11 2RN

Tel - 01383 414000
Fax - 01383 414400
E-Mail - rosyth@rearo.co.uk

Rearo Gateshead
Unit 3
Eastern Avenue Trade Park
Team Valley
Gateshead
NE11 0PG

Tel - 0191 482 2298
Fax - 0191 482 6245
E-Mail - gateshead@rearo.co.uk

Rearo Supplies Limited
Gas Depot
North Road
Lerwick
Shetland Isles
ZE1 0QA

Tel - 01595 692807
Fax - 01595 695469
E-Mail - gas@rearo.co.uk

Rearo Laminates (Southwest) Ltd
Unit 14 & 15 Estuary Court
Estuary Road
Queensway Meadows
Newport, Gwent
NP19 4SP

Tel - 01633 283000
Fax - 01633 283001
E-Mail - newport@rearo.co.uk